

KINDERGARTEN

Holiday homework for winter vacation

(2015-2016)



# डी. ए.वी पब्लिक स्कूल

## सेक्टर-6 द्वारका

रेफरन्स न. ....

दिनांक .....

नाम .....

कक्षा.....

चित्र देख कर अक्षर लिखो

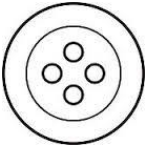

\_\_\_\_\_

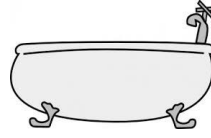

\_\_\_\_\_



\_\_\_\_\_



\_\_\_\_\_

रिक्त स्थान भरो

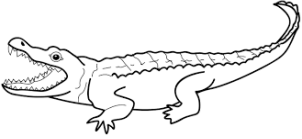

मग



ट

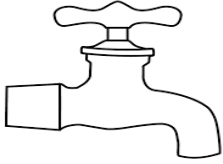

ल



बत

लय वाले शब्द

महल - \_\_\_\_\_

चमक - \_\_\_\_\_

नरम - \_\_\_\_\_

सड़क - \_\_\_\_\_

# डी. ए.वी पब्लिक स्कूल

## सेक्टर-6 द्वारका

रेफरन्स न. ....

दिनांक .....

नाम .....

कक्षा.....

### शब्द लिखो

दो वर्ण

तीन वर्ण

चार वर्ण

_____	_____	_____
_____	_____	_____
_____	_____	_____
_____	_____	_____

# DAV Public School

Sector VI, Dwarka, New Delhi

Ref.no. \_\_\_\_\_

Date \_\_\_\_\_

Subject- English

Name \_\_\_\_\_

Class- Pre Primary \_\_\_\_\_

Write the correct vowel in the given box to make a word.



r		m
---	--	---



h		n
---	--	---



g		m
---	--	---



k		t
---	--	---

a e i o u

# DAV Public School

Sector VI, Dwarka, New Delhi

Ref.no. \_\_\_\_\_



Date \_\_\_\_\_

Subject- English

Name \_\_\_\_\_

Class- Pre Primary \_\_\_\_\_

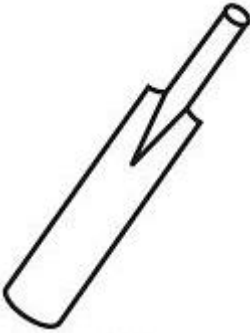
Look at the picture & make a word from the given letters.

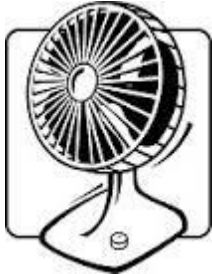
	<table border="1"><tbody><tr><td>c</td><td>-</td><td>a</td><td>m</td></tr><tr><td>x</td><td>i</td><td>t</td></tr></tbody></table>	c	-	a	m	x	i	t	<p>_____</p> <p>_____</p> <p><b>cat</b></p> <p>_____</p>
c	-	a	m						
x	i	t							
	<table border="1"><tbody><tr><td>b</td><td>a</td><td>k</td></tr><tr><td>j</td><td>o</td><td>t</td></tr></tbody></table>	b	a	k	j	o	t	<p>_____</p> <p>_____</p> <p>_____</p>	
b	a	k							
j	o	t							
	<table border="1"><tbody><tr><td>c</td><td>i</td><td>m</td></tr><tr><td>j</td><td>a</td><td>t</td></tr></tbody></table>	c	i	m	j	a	t	<p>_____</p> <p>_____</p> <p>_____</p>	
c	i	m							
j	a	t							
	<table border="1"><tbody><tr><td>f</td><td>e</td><td>n</td></tr><tr><td>t</td><td>a</td><td>p</td></tr></tbody></table>	f	e	n	t	a	p	<p>_____</p> <p>_____</p> <p>_____</p>	
f	e	n							
t	a	p							

# DAV Public School

Sector VI, Dwarka, New Delhi

Ref.no. \_\_\_\_\_

Date \_\_\_\_\_

## Worksheet Subject- EVS

Name \_\_\_\_\_

Class- Pre Primary \_\_\_\_\_

1. Draw the tools of each helper in the space provided?



2. Match the animals with their homes?

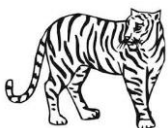
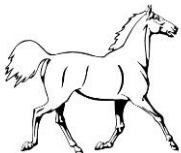
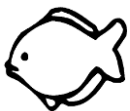

3. Label the different parts of a plant?

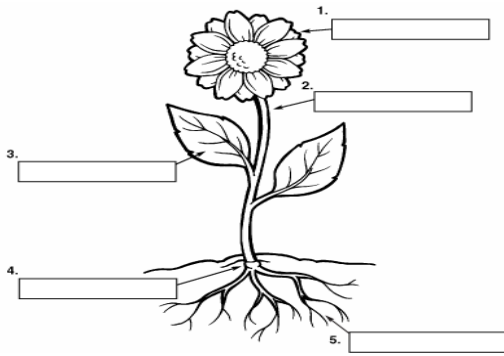

4. Draw a circle on living things and cross the non living things?



5. See the below pictures and write W for water transport, L for land transport and A for air transport?

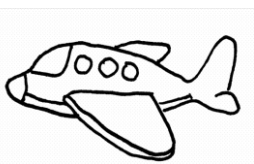
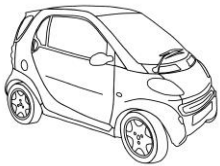
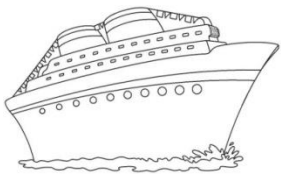

**D A V Public School**  
**Sector-6 Dwarka, New Delhi-110075**

Date-\_\_\_\_\_

**WORKSHEET**

**Subject: Mathematics**

Name-\_\_\_\_\_

Class-Pre-Primary

**Q1. Fill the missing numbers.**

a. 59 \_\_\_\_\_ 62 \_\_\_\_\_

b. 88,89 \_\_\_\_\_ 93

**Q2. What comes**

**Before**

**After**

**Between**

\_\_\_\_\_ 74

46 \_\_\_\_\_

39 \_\_\_\_\_ 41

\_\_\_\_\_ 30

51 \_\_\_\_\_

79 \_\_\_\_\_ 81

**Q3. Solve.**

**13**

**16**

**11**

**14**

**17**

**+ 5**

**- 8**

**+ 7**

**- 4**

**- 0**

\_\_\_\_\_

\_\_\_\_\_

\_\_\_\_\_

\_\_\_\_\_

\_\_\_\_\_

**Q4. Mental Maths**

a. **10 - 5 = \_\_\_\_\_**

b. **12 - 6 = \_\_\_\_\_**

c. **13 + 4 = \_\_\_\_\_**



**Q5. Concept of tens and ones.**

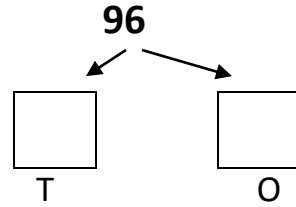
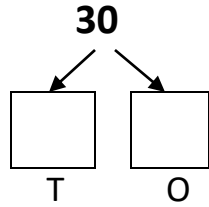
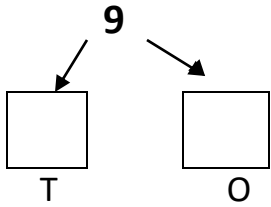

**Q6. Draw the beads on abacus.**

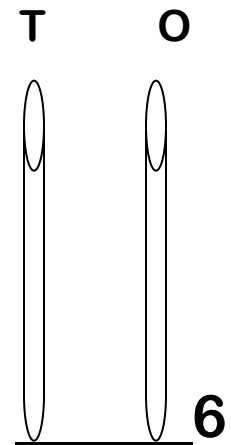
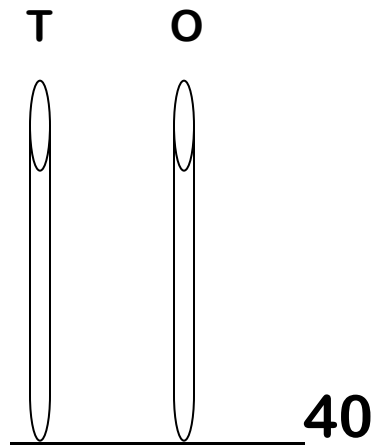
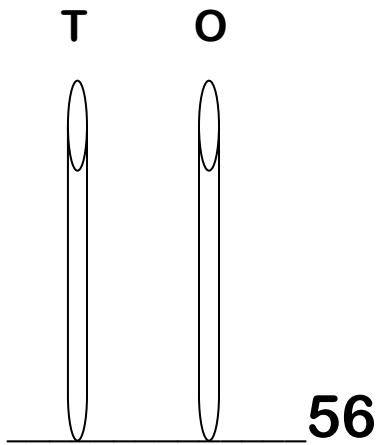

**Q7. Draw two objects of each**

**a. Light weight**

\_\_\_\_\_

\_\_\_\_\_

**b. Heavy weight**

\_\_\_\_\_

\_\_\_\_\_

Join the dots from 1 to 50 in sequence and complete the picture.

Now color it.

